

Features

- 100Watts peak pulse power ($t_p = 8/20\mu s$)
- Bidirectional configurations
- Solid-state silicon-avalanche technology
- Low clamping voltage
- Low leakage current
- Low capacitance ($C_j = 0.7pF$ typ.)

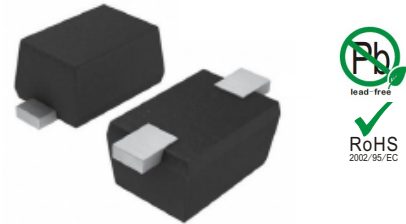

SOD-523

IEC COMPATIBILITY (EN61000-4)

- IEC 61000-4-2 $\pm 25kV$ contact $\pm 25kV$ air
- IEC 61000-4-4 (EFT) 40A (5/50ns)
- IEC 61000-4-5 (Lightning) 7A (8/20 μs)

Applications

- Cell Phone Handsets and Accessories
- Microprocessor based equipment
- Personal Digital Assistants (PDA's)
- Notebooks, Desktops, and Servers
- Portable Instrumentation

Mechanical Characteristics

- SOD523 package
- Molding compound flammability rating:
UL 94V-0
- Packaging: Tape and Reel
- RoHS/WEEE Compliant

Schematic & PIN Configuration

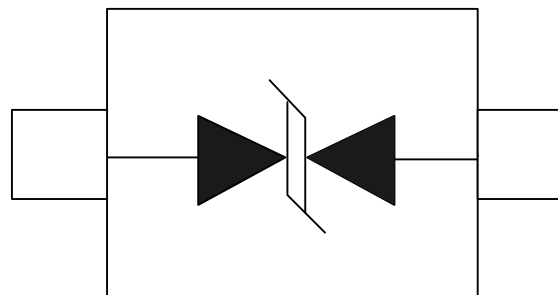

SOD-523

Absolute Maximum Rating

Rating	Symbol	Value	Units
Peak Pulse Power ($t_p = 8/20\mu s$)	P_{PP}	100	Watts
Peak Pulse Current ($t_p = 8/20\mu s$) (note1)	I_{PP}	7	A
ESD per IEC 61000-4-2 (Air) ESD per IEC 61000-4-2 (Contact)	V_{ESD}	25 25	kV
Lead Soldering Temperature	T_L	260(10seconds)	$^{\circ}C$
Junction Temperature	T_J	-55 to + 125	$^{\circ}C$
Storage Temperature	T_{stg}	-55 to + 125	$^{\circ}C$

Electrical Characteristics

Parameter	Symbol	Conditions	Min	Typical	Max	Units
Reverse Stand-Off Voltage	V_{RWM}				5.0	V
Reverse Breakdown Voltage	V_{BR}	$I_T = 1mA$	6.0	8.0		V
Reverse Leakage Current	I_R	$V_{RWM} = 5V, T = 25^{\circ}C$		0.1	0.5	μA
Peak Pulse Current	I_{PP}	$t_p = 8/20\mu s$			7	A
Clamping Voltage	V_C	$I_{PP} = 7A, t_p = 8/20\mu s$			16	V
Junction Capacitance	C_j	$V_R = 0V, f = 1MHz$		0.7	0.8	pF

Electrical Parameters (TA = 25°C unless otherwise noted)

Symbol	Parameter
I_{PP}	Maximum Reverse Peak Pulse Current
V_C	Clamping Voltage @ I_{PP}
V_{RWM}	Working Peak Reverse Voltage
I_R	Maximum Reverse Leakage Current @ V_{RWM}
V_{BR}	Breakdown Voltage @ I_T
I_T	Test Current

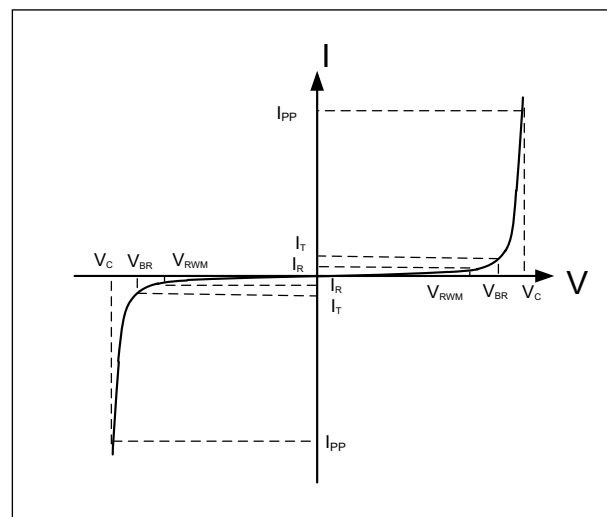

Note.: 8/20 μs pulse waveform.

Typical Characteristics

Figure 1: Peak Pulse Power vs. Pulse Time

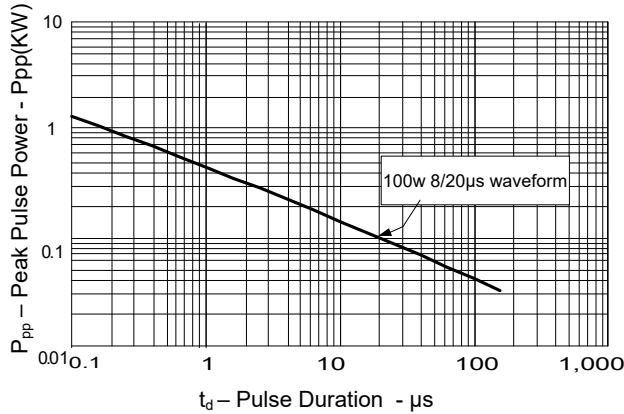

Figure 2: Power Derating Curve

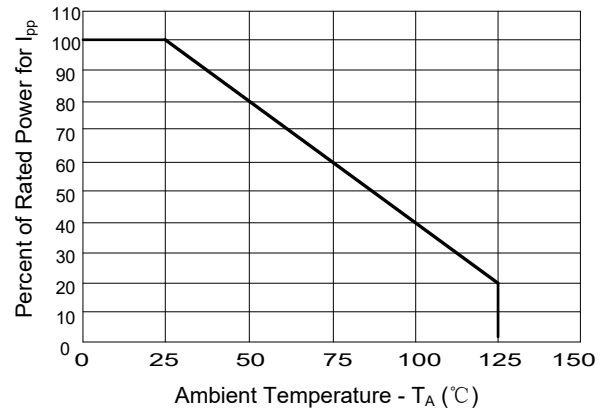

Figure 3: Pulse Waveform

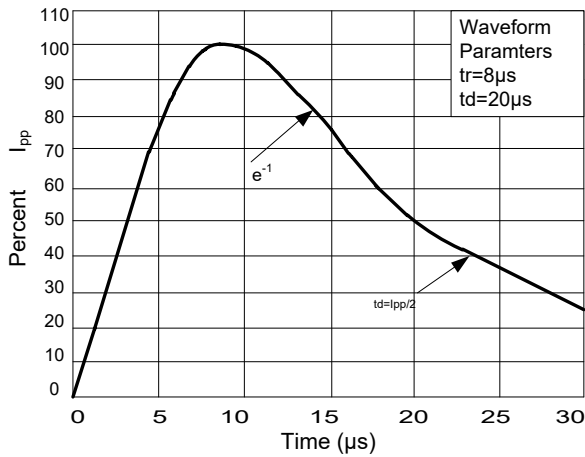
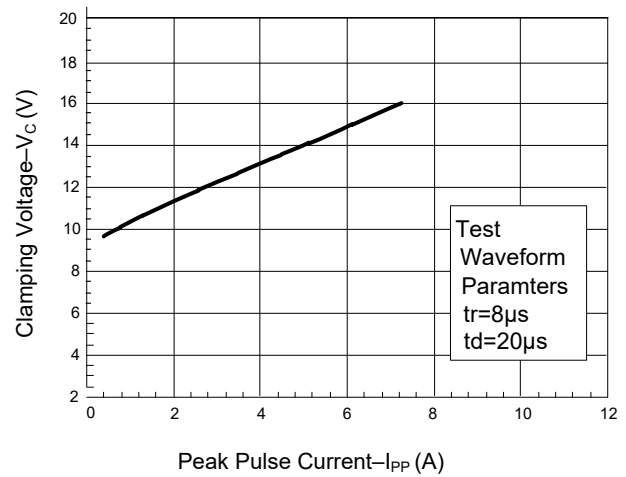
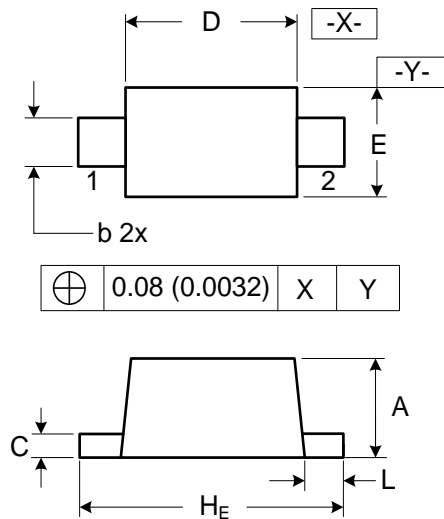

Figure 4: Clamping Voltage vs. I_pp



Outline Drawing



SYMBOL	DIMENSIONS			
	MILLIMETER		INCHES	
	MIN	MAX	MIN	MAX
A	0.50	0.70	0.020	0.028
b	0.25	0.35	0.010	0.014
C	0.07	0.20	0.0028	0.0079
D	1.10	1.30	0.043	0.051
E	0.70	0.90	0.028	0.035
H_E	1.50	1.70	0.059	0.067
L	0.15	0.25	0.006	0.010

Ordering information

Order code	Package	Base qty	Delivery mode
PTD522L07M5B10	SOD523	5K	Tape and reel