

PSRP Series-Prosemi Shunt Resistors

Features

- Metal Alloy Low-Resistance shunt resistor.
- Resistance value 0.2mΩ, 0.3mΩ, 0.5mΩ, 1mΩ, 2mΩ, 3mΩ, 4mΩ.
- Low thermal EMF.
- Low TCR.
- Very low inductance.
- Halogen free, lead free and RoHS compliant.

Applications

- Power modules.
- Frequency converters.
- Current sensor for power hybrid sources high current for automotive.
- Lithium battery protection board.

Part Number

PSRP 25 S 6 F 0M50

【1】 【2】 【3】 【4】 【5】 【6】

【1】 Series Name: Prosemi Shunt Resistor for High Power Applications.

【2】 Chip Size: 25: 2512, 39: 3921, 59: 5930

【3】 Material: S: CuMnSn, M: CuMn, K: NiCr , C: Ni & Sn plated Copper.

【4】 Power Rating: 15=15W, 10=10W, 6=6W, 4=4W, J=Jumper.

【5】 Resistance Precision: D: ±0.5%, F: ±1%, J: ±5%, 0: Jumper.

【6】 Resistance Code: R000: Jumper, R002: 2mΩ, 0M50: 0.5mΩ.

Electrical Characteristics

Size	Power Rating at 70°C(W)	Resistance Range (mΩ)* ±0.5%; ±1%; ±5%	Operation Temperature Range	Product temperature coefficient (ppm/°C)
2512	6	0.3~2	-55°C~+150°C	±250 for 0.3 mΩ and 0.5 mΩ ±200 for 1mΩ ±75 for 2~4 mΩ
	4	3~4		
	$I_{max}=100A$	Jumper	-	-
3921	9	0.5~1	-55°C~+150°C	±75 for 0.5 mΩ and 1 mΩ
5930	15	0.2	-55°C~+150°C	±100 for 0.2mΩ ±75 for 0.5 mΩ
	10	0.5		

“*” : Other values may be available, contact factory

Note:

- 1) $I_r = (P/R)^{1/2}$ R: Resistance Value I_r : Rating Current P: Rating Power;
- 2) Product temperature coefficient: Includes the TCR effects of the resistor element and the copper terminal.

Physical Dimensions

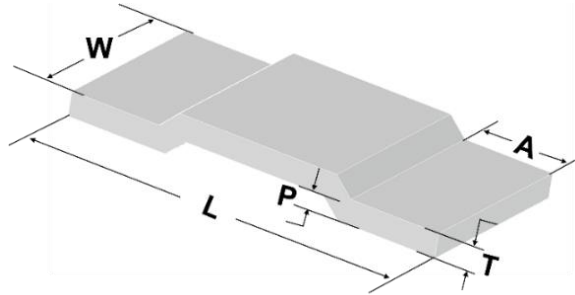

Unit: mm

Size	Resistance (mΩ)	L	W	T	A	P	Element Material
2512	Jumper	6.4±0.2	3.2±0.2	-	1.53±0.2	0.4±0.1	Ni & Sn plated Copper
	0.3			0.95±0.1			CuMn
	0.5			0.4±0.1			CuMnSn
	1			0.3±0.1			CuMn
	2			0.5±0.1			NiCr
	3			0.3±0.1			NiCr
	4			0.25±0.1			NiCr
3921	0.5	10±0.2	5.2±0.2	0.8±0.1	1.9±0.2	0.5±0.1	CuMn
	1			0.4±0.1			CuMn
5930	0.2	15±0.2	7.6±0.2	1.5±0.1	4.2±0.2	0.5±0.1	CuMn
	0.5			0.6±0.1			CuMn

Recommended Solder Pad Layout

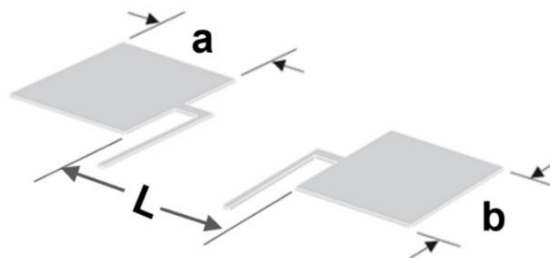

Unit: mm

Type	L	a	b
2512	3.0	2.3	3.5
3921	5.6	2.7	6.2
5930	5.6	5.2	8.75

Construction

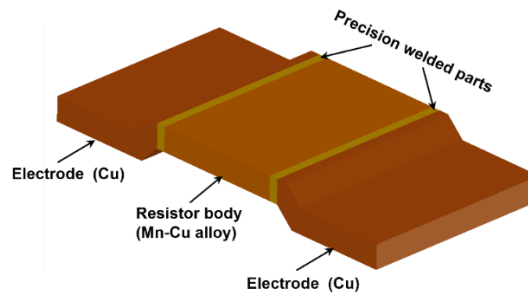

Power Derating Curve

For resistors operated in ambient temperatures 70°C, power rating shall be derated in according with the curve below:

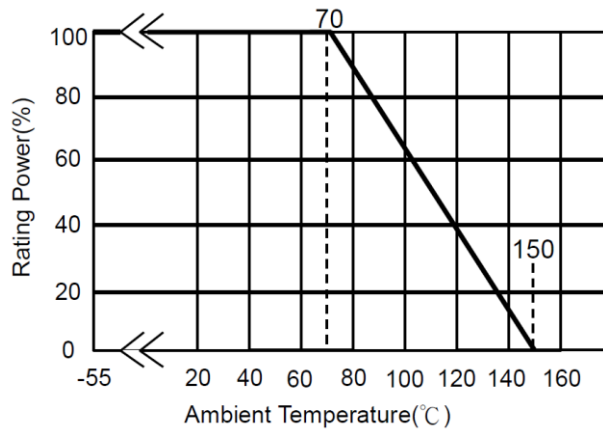

Recommended Solder Curve

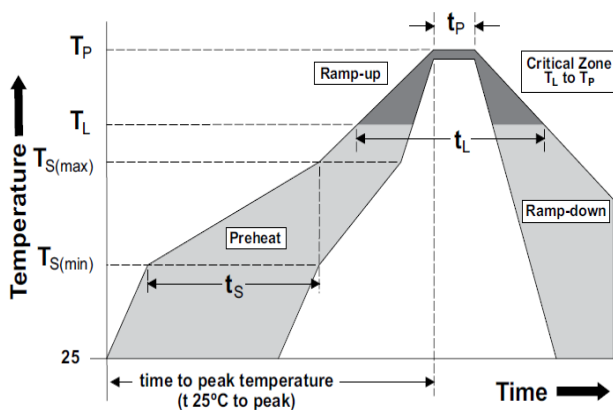

Reflow Condition		Pb – Free assembly
Pre heat	- Temperature Min (Ts(min))	150°C
	- Temperature Max (Ts(max))	200°C
	- Time (Min to Max) (ts)	60 – 120 secs
Average ramp up rate (Liquidus Temp (TL) to peak)		5°C/second max
Ts(max) to TL - Ramp-up Rate		5°C/second max
Reflow	- Temperature (TL) (Liquidus)	217°C
	- Time (tL)	60 – 150 seconds
Peak Temperature (TP)		260°C
Time within 5°C of actual peak Temperature (tp)		20 – 40 seconds
Ramp-down Rate		5°C/second max
Time 25°C to peak Temperature (TP)		8 minutes Max.
Wave Soldering		Not applicable
Hand Soldering		350°C, 5 seconds max.

Marking Instructions

PSRP is marked with three or four digit, We have two different ways of marking:

a. "R" designates the decimal location in ohms,

e. g. For PSRP39、PSRP59: 1mΩ: R001; For PSRP25: 1mΩ: 001

b. "m" designates the decimal location in milliohms,

e. g. For PSRP39、PSRP59: 0.5mΩ: 0m50; For PSRP25: 0.5mΩ: 0m5

Product Characteristics

Item	Test condition/ Methods	Limited	Standard
Resistance	Measuring resistance value at room temperature 25°C±5°C	Refer to Spec	IEC60115-1 4.5
Temperature coefficient of resistance	$TCR = (R - R_0) / R_0 (T_2 - T_1) \times 10^6$ R ₀ : resistance of room temperature R: resistance of 125°C T ₁ : Room temperature T ₂ : Temperature at 125°C	Refer to Spec	MIL-STD-202 Method 304
Short time Overload	5 times the rated power for 5 seconds	≤±0.5%	MIL-R-26E
Resistance to Soldering Heat	260°C± 5°C time: 12sec± 0.5sec	≤±0.5%	MIL-STD-202 Method 210
Temperature Cycling	-55°C (15min)/+150°C(15min), 1000 cycles	≤±0.5%	MIL-STD-202 Method107G
Low temperature Storage	-55 °C for 24 h	≤±0.5%	MIL-STD-26E
High Temperature Storage	150°C for 1000hours, No power	≤±1%	IEC6011501- 4.25
Bias Humidity	+85°C, 85% RH, 10%bias, 1000hours	≤±0.5%	MIL-STD-202 Method103
Mechanical shock	Condition C ,100 g's ,6 msec, 3 mutually perpendicular axes, in 6 directions, three impacts each for a total of 18 times 18 shocks.	≤±0.5%	MIL-STD-202 Method 213
Vibration	The frequency varies from 10HZ to 55HZ and return to 10HZ, shall be transferred in 1 min. Amplitude : 1.5mm, 3 directions, and 12 hours	≤±0.5%	MIL-STD-202 Method 201
Operational life	70°C± 2°C, 1000 hours, at rated power 1.5 hours "ON", 0.5 hours "OFF"	≤±1%	MIL-STD-202 Method 108
Moisture resistance	MIL-STD-202,method106, No power, 7b not required.	≤±0.5%	MIL-STD-202 Method 106

Packaging

Tape Dimensions

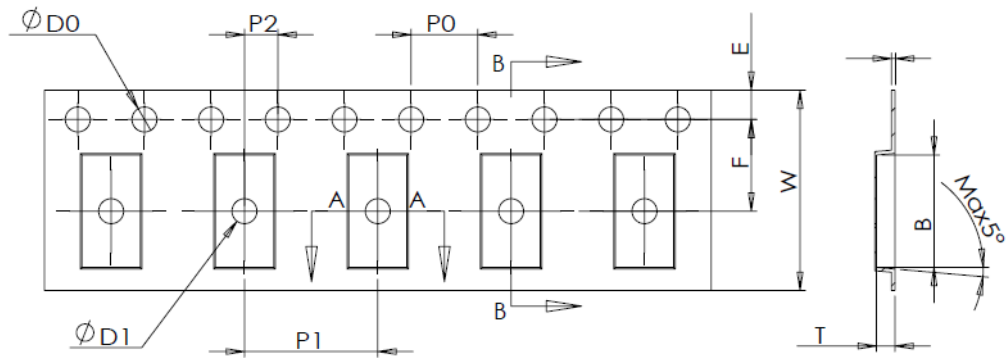

2512、3921

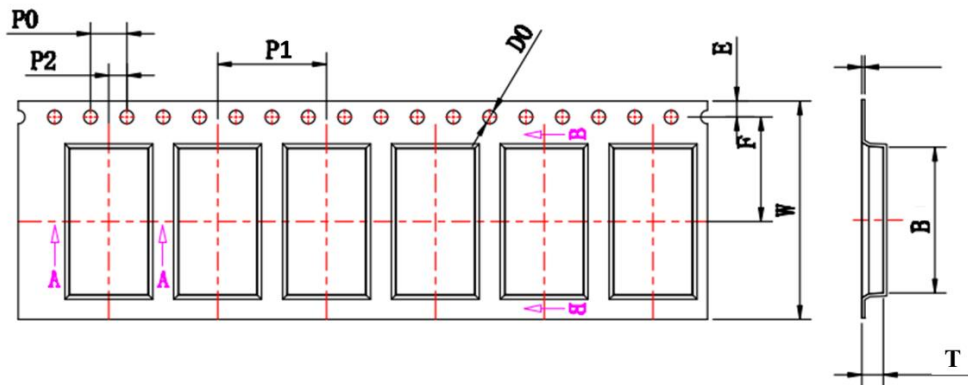

5930

Unit: mm

Series	Type	A	B	D0	E	F	φD1
2512	0.3mΩ	3.60±0.10	6.70±0.10	1.50+0.10	1.75±0.10	5.50±0.05	1.50±0.10
	0.5-4mΩ	3.50±0.10	6.74±0.10	1.50+0.10	1.75±0.10	5.50±0.05	1.50±0.10
3921	0.5-1mΩ	5.50±0.10	10.50±0.10	1.50+0.10/0	1.75±0.10	7.50±0.1	1.50+0.10/0
5930	0.2-0.5mΩ	8.60±0.10	16.00±0.10	1.50+0.10/0	1.75±0.10	11.50±0.1	/
Series	Type	W	P0	P1	P2	T	
2512	0.3mΩ	12.00±0.30	4.00±0.10	8.00±0.10	2.00±0.05	1.60±0.10	
	0.5-4mΩ	12.00±0.30	4.00±0.10	8.00±0.10	2.00±0.05	1.10±0.10	
3921	0.5-1mΩ	16.00±0.30	4.00±0.10	8.00±0.10	2.00±0.10	1.50±0.10	
5930	0.2-0.5mΩ	24.00±0.30	4.00±0.10	12.00±0.10	2.00±0.10	2.40±0.10	

Reel Dimensions



2512

3921、5930

Unit: mm

Series	Type	W (mm)	M (mm)	A (mm)	B (mm)	C (mm)	D (mm)
2512	7' reel	13.8±0.5	178.0±2.0	2.0±0.5	13.5±0.5	21.0±0.5	80.0±1.0
Series	Type	W (mm)	M (mm)	ΦA (mm)	N (mm)	H1 (mm)	B (mm)
3921	13' reel	16.4+3.5/-0.2	330.0±2.0	13.4±0.5	100.0±0.2	16.4±1.0	2.4±0.4
5930	13' reel	24.4+3.5/-0.2	330.0±2.0	13.4±0.5	100.0±0.2	24.4±1.0	2.4±0.4

Quantity of Package

Type	Quantity(pcs)
2512	0.3mΩ: 1000 0.5-4mΩ: 2000
3921	2500
5930	2000

Storage

1. The temperature condition must be controlled at $25\pm 5^{\circ}\text{C}$, The R.H. must be controlled at $60\pm 15\%$ Store in accordance with this requirement, and the validity period is two years after the date of manufacture.
2. Please avoid the mentioned harsh environment below when storing to ensure product performance and its' weldability. Places exposed to sea breeze or other corrosive gas, such as Cl_2 , H_2S , NH_3 , SO_2 and NO_2 .
3. When the product is moved and stored, please ensure the correct orientation of the box. Do not drop or squeeze the box. Otherwise, the electrode or the body of the product may be damaged.